

符号 MARK	訂正記録 REVISION RECORD	日付 DATE	署名 NAME
△			

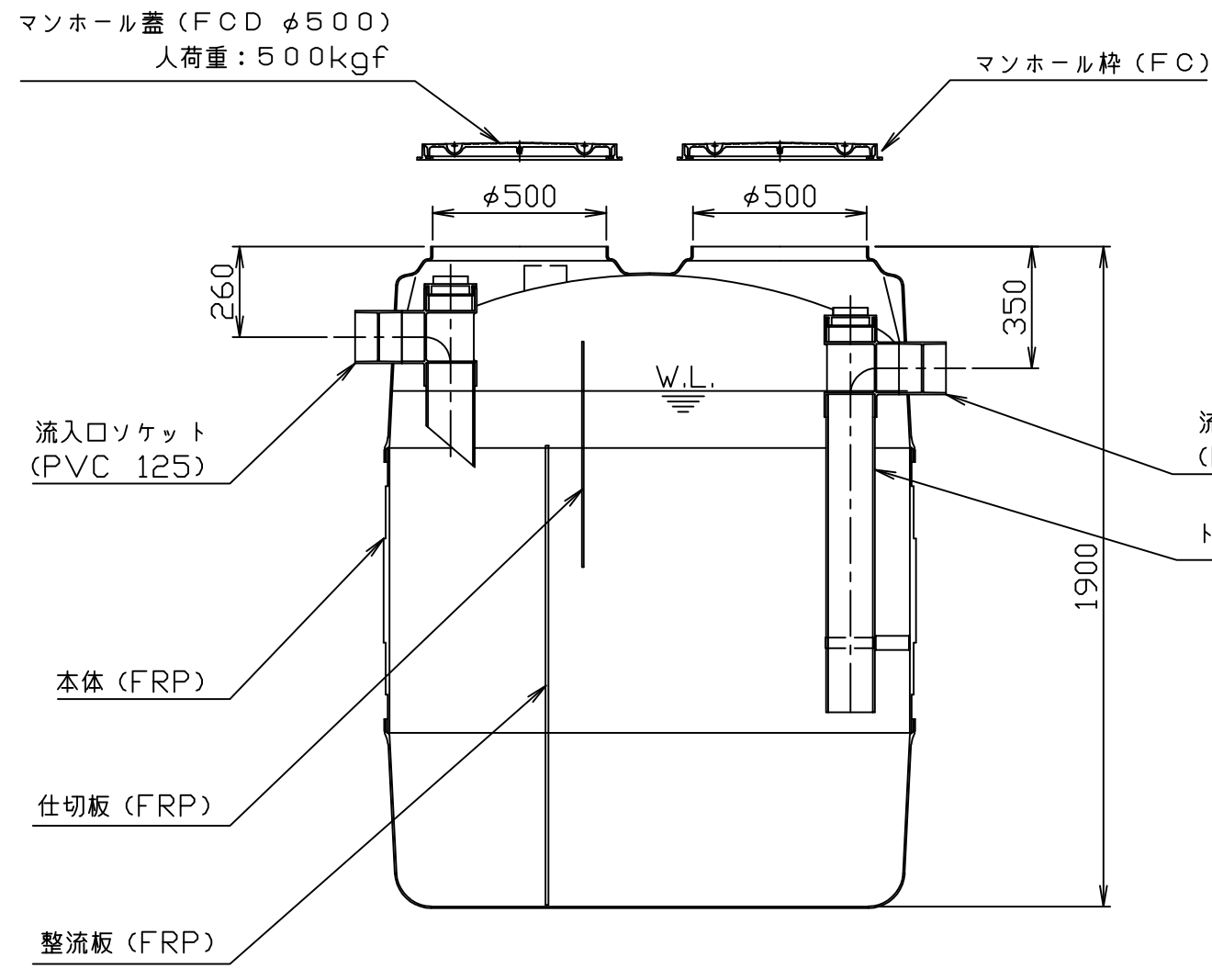
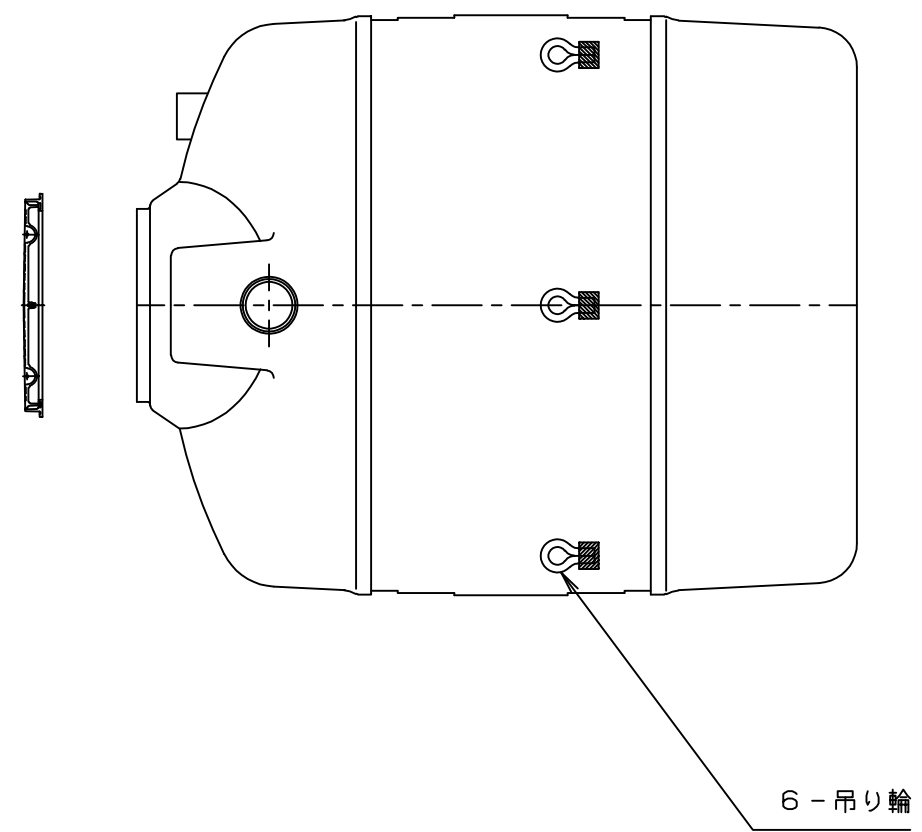
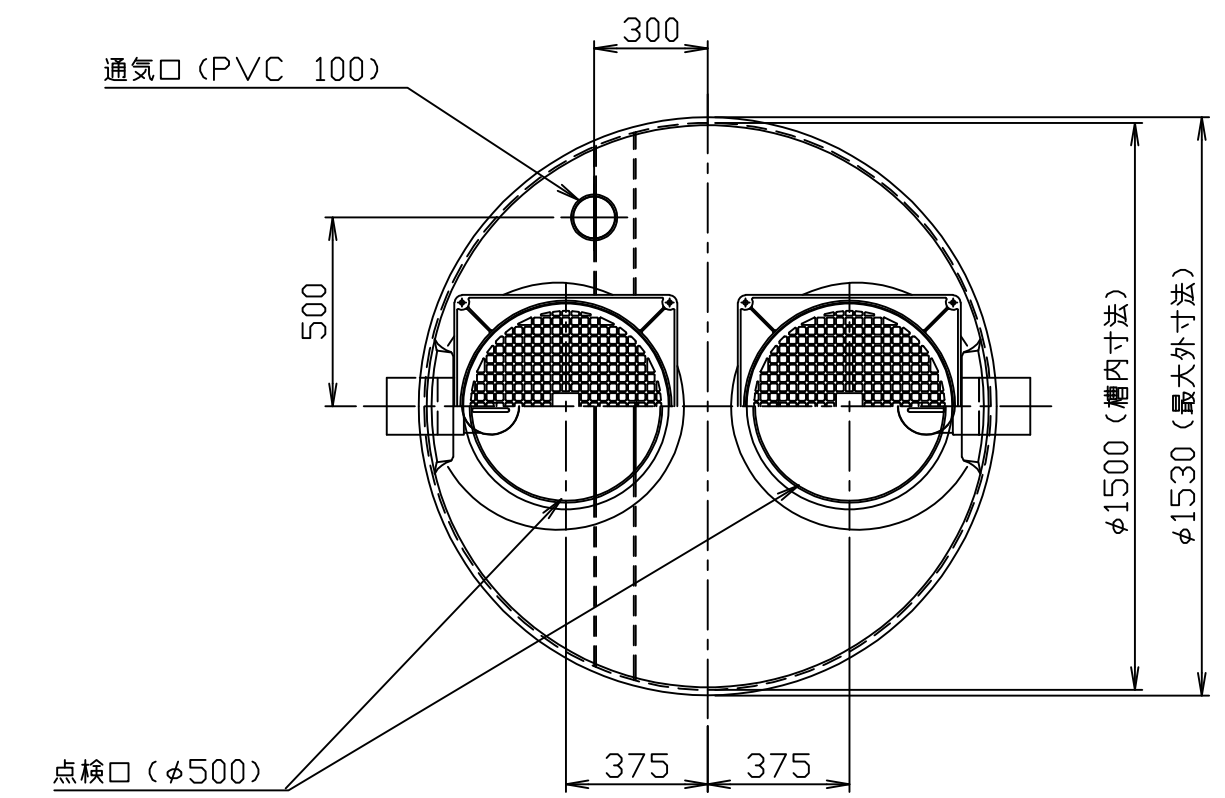

許容流入流量：750.0 (L/min)
 標準阻集グリース量：590.6 (kg)
 本体質量：175 (kg)
 蓋枠質量：74 (kg)

注番 ORDER No.	三角法 THIRD ANGLE PROJECTION	尺度 SCALE 1/20	名称 NAME 丸型グリース阻集器
設計 DESIGNED 岩岡	検図 CHECKED 大平	担当 SECTION STAFF ,,	型式 TYPE MF-2500
2005,04,20	2005,04,20		個数 QTY 1
現場名 OBJECT			備考 NOTE
ホークス株式会社 HORKOS CORP.		図番 FILE NAME	017703000A010C