

符号 MARK	訂正記録 REVISION RECORD	日付 DATE	署名 NAME
△			

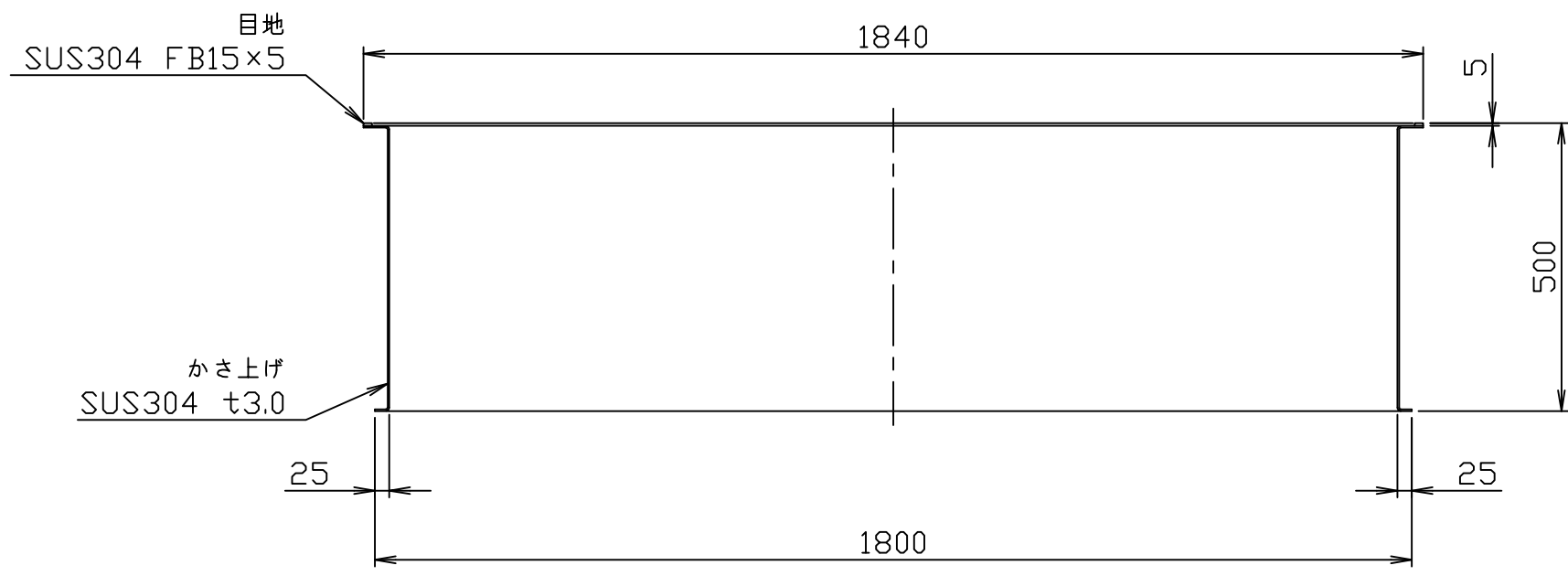
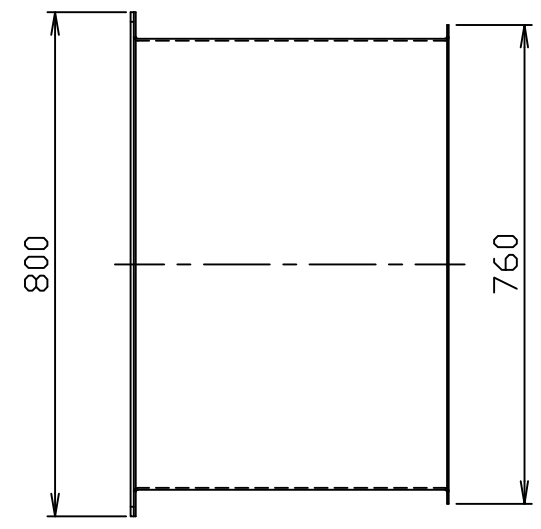
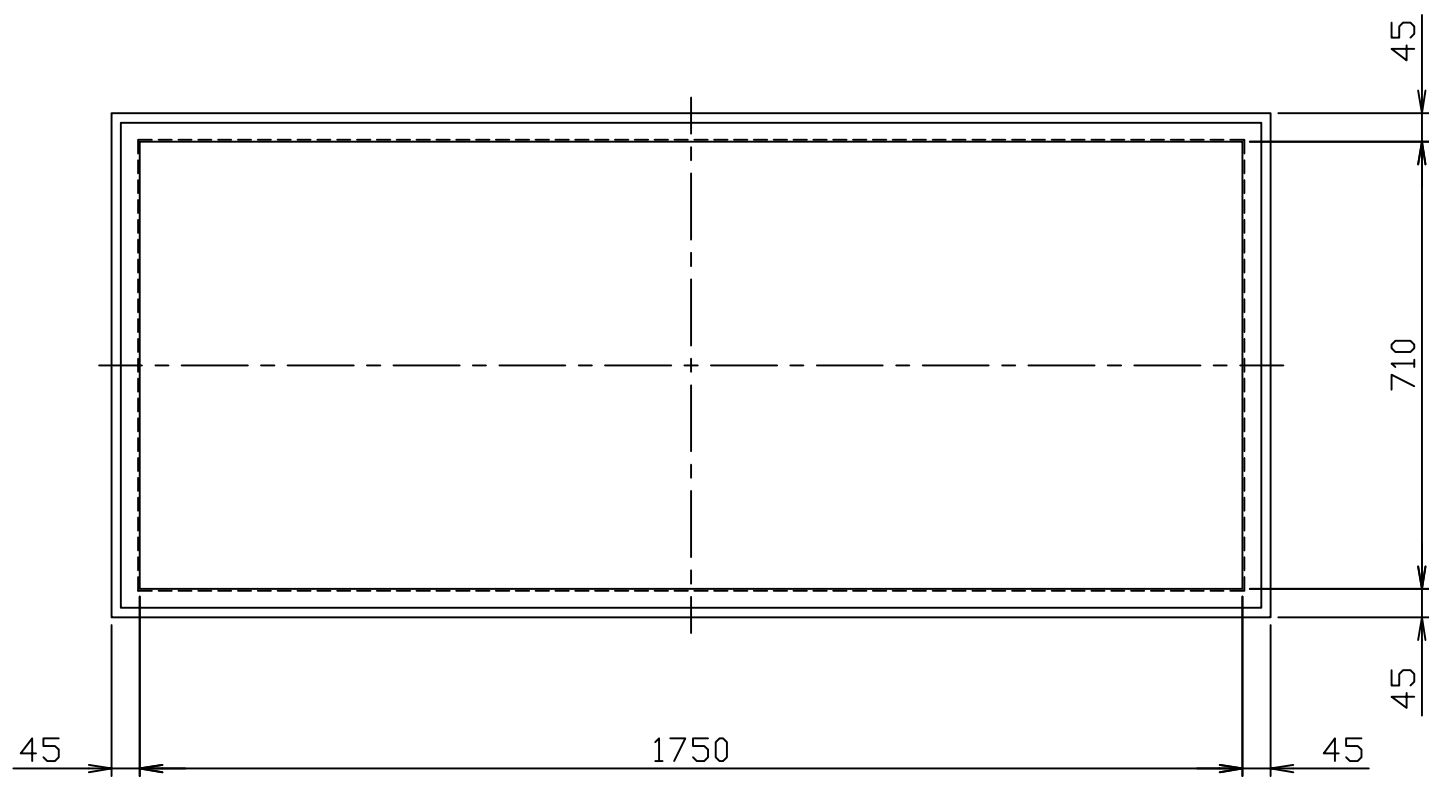

適応機種：GSU-N170JE II、JPI I

注番 ORDER No.	三角法 THIRD ANGLE PROJECTION	尺度 SCALE 1/12	名称 NAME かさ上げ
設計 DESIGNED 影久	検図 CHECKED 佐藤太	担当 SECTION STAFF	型式 TYPE KU-N170
2017, 09, 01	2017, 09, 01	, ,	備考 NOTE 500H
ホークス株式会社 HORKOS CORP		図番 FILE NAME	0 H 8 8 2 9 A 0 1 A 0 1 1 0