

符号 MARK	訂正記録 REVISION RECORD	日付 DATE	署名 NAME
△			

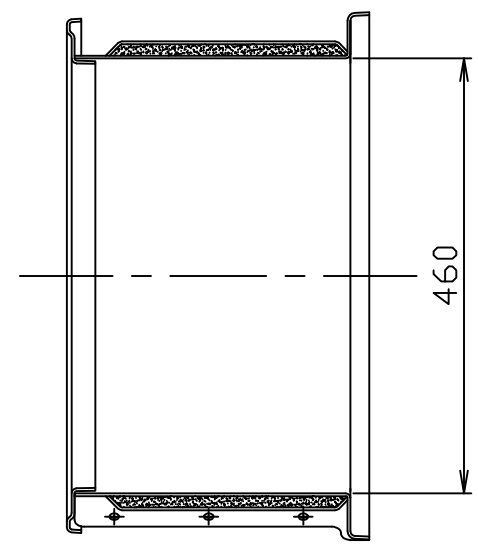

BB' 断面

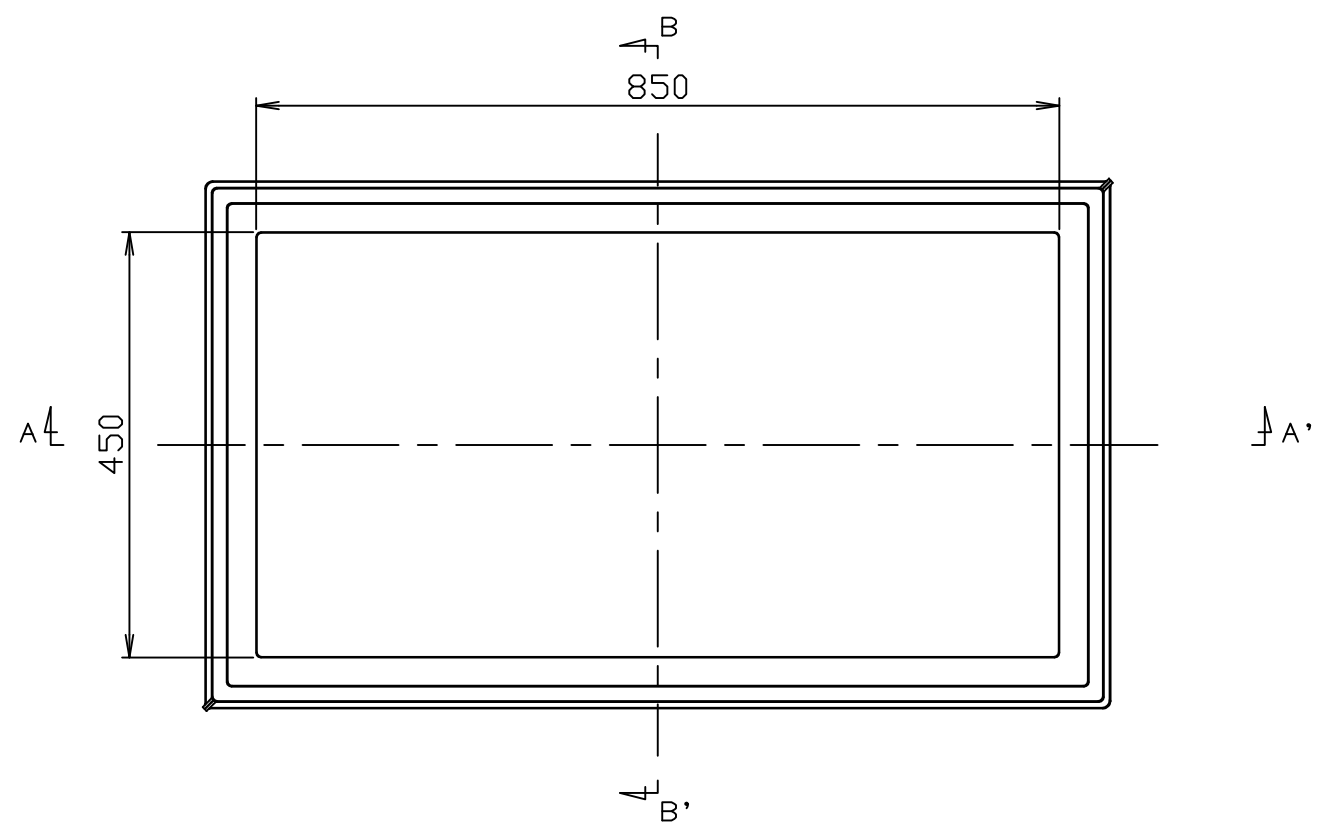
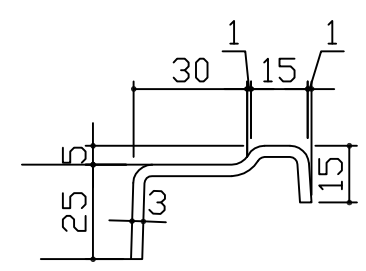

Y部詳細

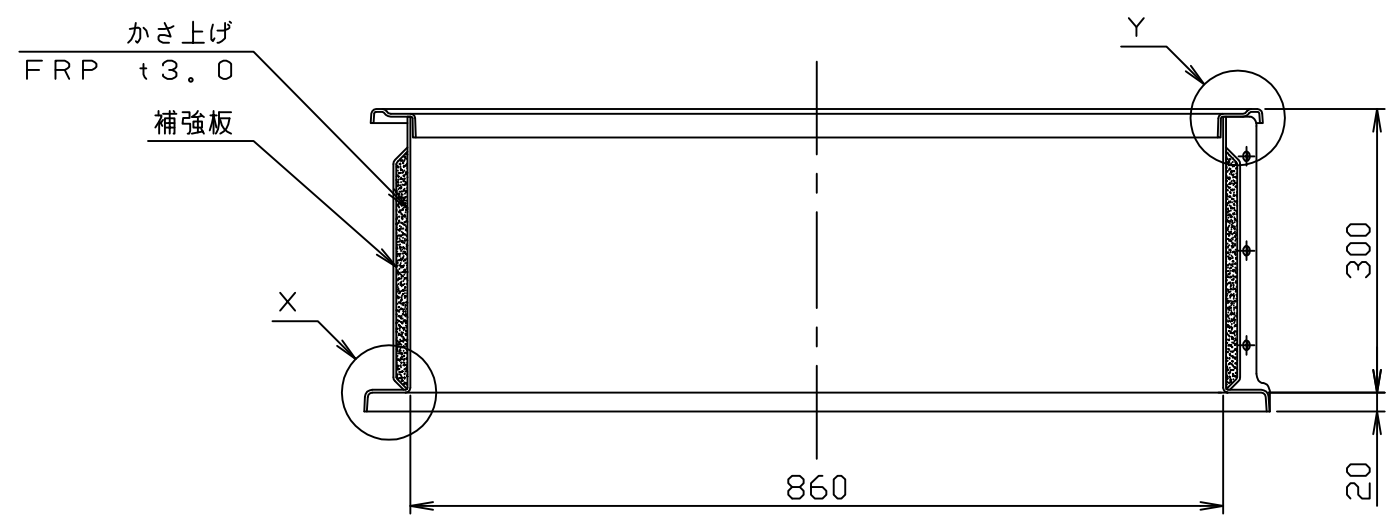

AA' 断面

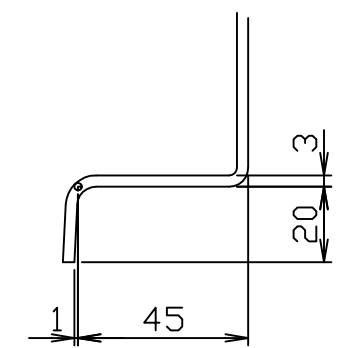

X部詳細

適応機種：RGR-NX120P

注番 ORDER No.	三角法 THIRD ANGLE PROJECTION	尺度 SCALE 1/8	名称 NAME かさ上げ
設計 DESIGNED 影久	検図 CHECKED 山本大	担当 SECTION STAFF	型式 TYPE KCR-NX120
2020, 09, 01	2020, 09, 01	現場名 OBJECT	備考 NOTE 300H
ホークス株式会社 HORKOS CORP		図番 FILE NAME	個数 QTY
		0 K 1 5 5 5 A 0 1 A 0 1 0 0	