

符号 MARK	訂正記録 REVISION RECORD	日付 DATE	署名 NAME
△			

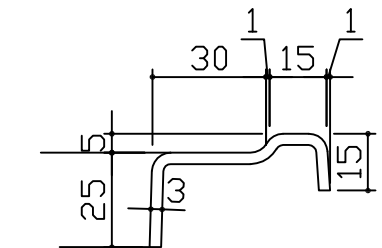

BB' 断面

Y部詳細

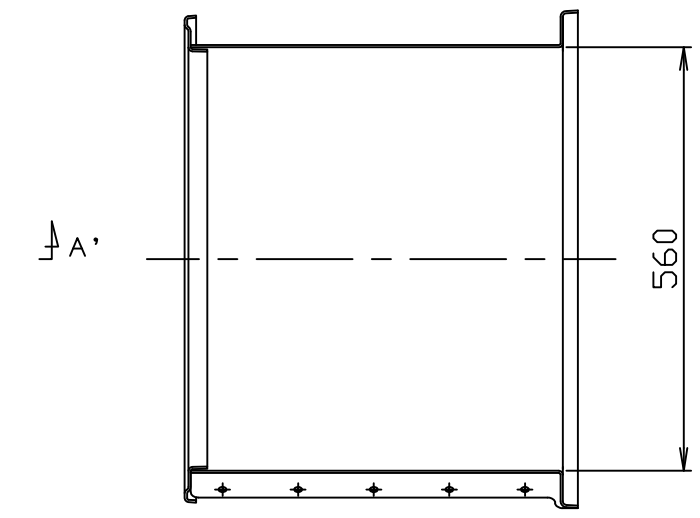
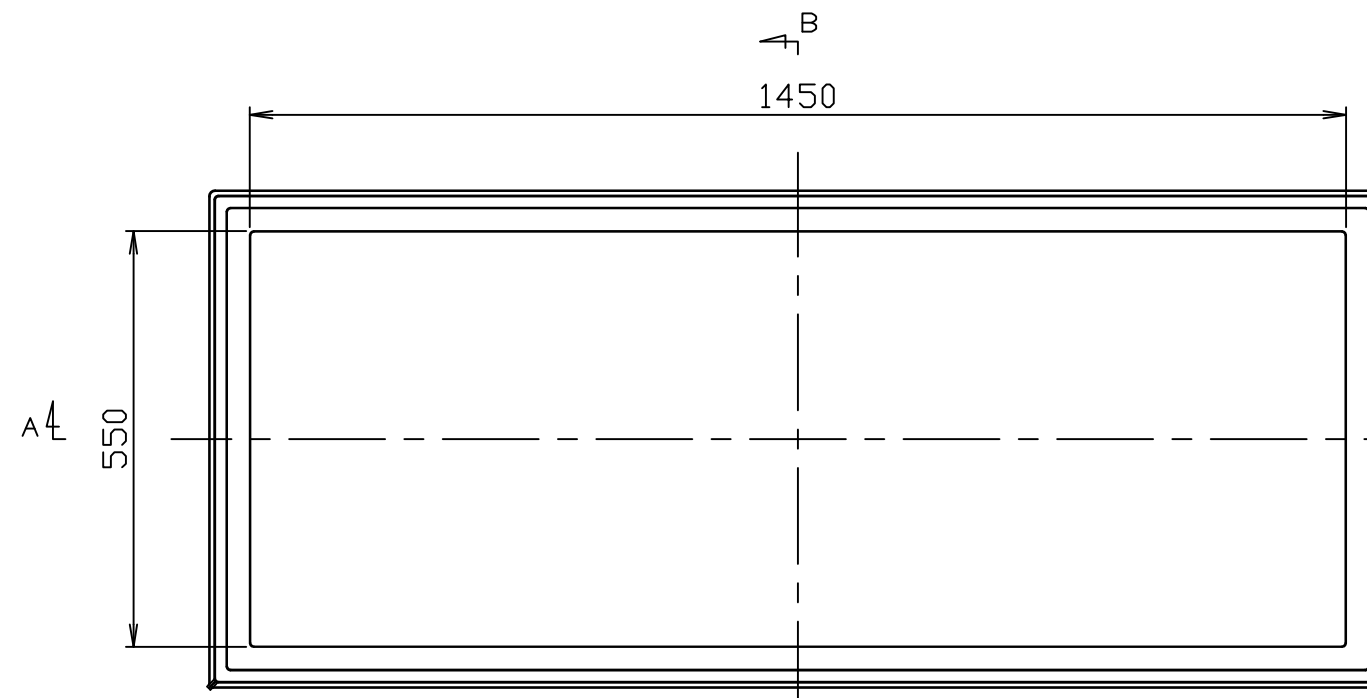
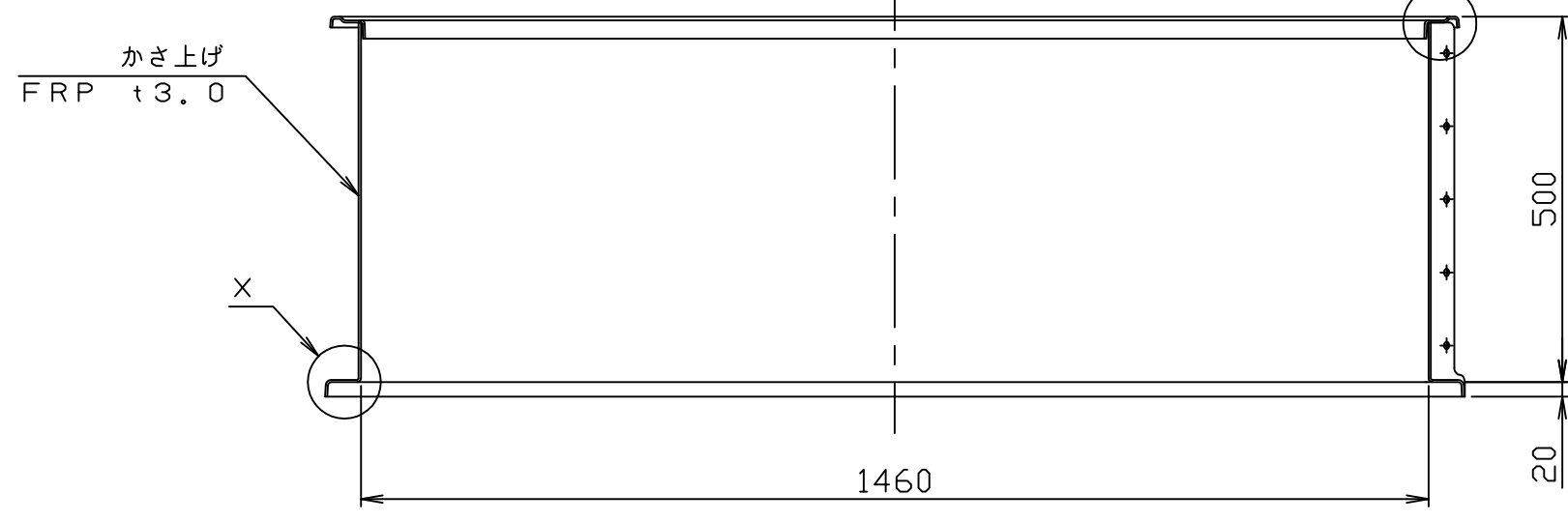

AA' 断面

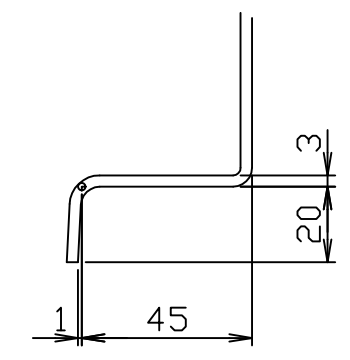

X部詳細

適応機種：HGR-NX300P

注番 ORDER No.	三角法 THIRD ANGLE PROJECTION	尺度 SCALE 1/10	名称 NAME かさ上げ
設計 DESIGNED 影久	検図 CHECKED 山本大	担当 SECTION STAFF	型式 TYPE KR-NX300
2020, 09, 01	2020, 09, 01	客先 CUSTOMER	個数 QTY
現場名 OBJECT		備考 NOTE 500H	
<b>ホークス株式会社</b> HORKOS CORP		図番 FILE NAME	0   K   1   5   3   4   A   0   1   A   0   1   0   0